

# Adapters · Extension bars

## アダプター・エクステンションバー

### MODEL Extension bar

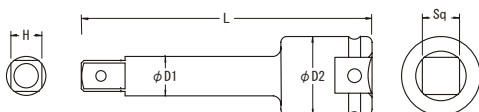

EDP #	Sq	H	D1	D2	L
BXB375	9.5	9.5	13	20	75
BXB3100	9.5	9.5	13	20	100
BXB3150	9.5	9.5	13	20	150
BXB3200	9.5	9.5	13	20	200
BXB4100	12.7	12.7	17	25	100
BXB4150	12.7	12.7	17	25	150
BXB4200	12.7	12.7	17	25	200
BXB6150	19	19	25	38	150
BXB6200	19	19	25	38	200

### MODEL Bit chuck



EDP #	Type	H	Sq	Application bit
BBA302B	Ball type	6.35	9.5	B-15 B-35
BBA402B	Ball type	6.35	12.7	B-15 B-35
BBA302S	Chuck Type	6.35	9.5	B-15 B-35
BBA402S	Chuck Type	6.35	12.7	B-12 B-39
BBA302G	Rubber type	6.35	9.5	B-15 B-35
BBA402G	Rubber type	6.35	12.7	B-12 B-39

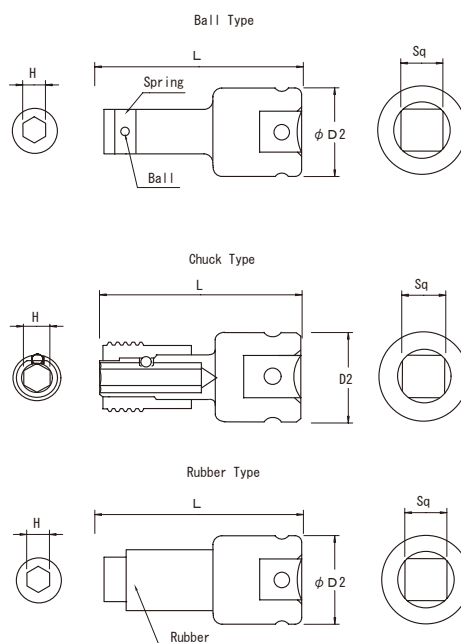

# Adapters · Extension bars



## アダプター・エクステンションバー

### MODEL Bit adapter



EDP #	Type	H	Sq	Application bit	
BDA203	Pin Type	6.35	9.5	B-15	B-35
BDA204	Pin Type	6.35	12.7	B-15	B-35
BDA203B	Ball type	6.35	9.5	B-15	B-35
BDA204B	Ball type	6.35	12.7	B-15	B-35

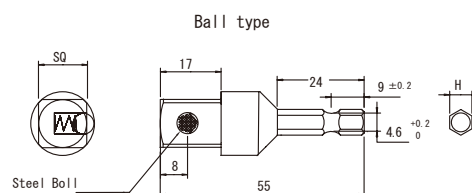
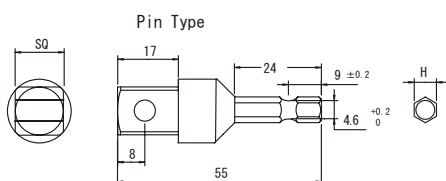

### MODEL Socket adapter



EDP #	Type	Sq	H	D2	L
BSA304	A	9.5	12.7	20	37
BSA403	A	12.7	9.5	25	37
BSA304B	B	9.5	12.7	20	37
BSA403B	B	12.7	9.5	25	37
BSA406	A	12.7	19	25	46
BSA604	A	19	12.7	38	53
BSA608	A	19	25.4	38	70

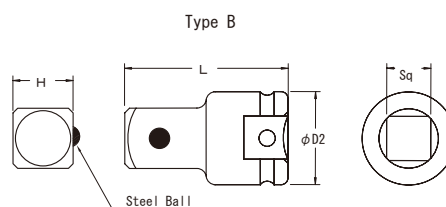
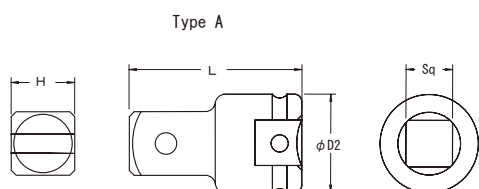

### MODEL Socket adapter type H



EDP #	H1	H2	L
BSA0810	8	10	40
BSA0812	8	12	40
BSA1008	10	8	40
BSA1012	10	12	40
BSA1014	10	14	40
BSA1208	12	8	41
BSA1210	12	10	42
BSA1214	12	14	43
BSA1410	14	10	44
BSA1412	14	12	45
BSA1417	14	17	46
BSA1714	17	14	47

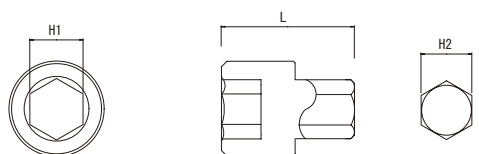

# Adapters · Extension bars

## アダプター・エクステンションバー

### MODEL Bit through socket



EDP #	Type(1)	bit diameter	H	L	Type(2)
BBS208	No magnet type R	6.35	8	60	No ball type
BBS210		6.35	10	60	No ball type
BBS212		6.35	12	60	No ball type
BBS214		6.35	14	60	No ball type
BBS208B	No magnet type B	6.35	8	60	Ball Stopper
BBS210B		6.35	10	60	Ball Stopper
BBS212B		6.35	12	60	Ball Stopper
BBS214B		6.35	14	60	Ball Stopper
BBS208MB	With magnet MB	6.35	8	60	Ball Stopper
BBS210MB		6.35	10	60	Ball Stopper
BBS212MB		6.35	12	60	Ball Stopper
BBS214MB		6.35	14	60	Ball Stopper
BBS208RMB	With ring magnet RMB	6.35	8	60	Ball Stopper
BBS210RMB		6.35	10	60	Ball Stopper
BBS212RMB		6.35	12	60	Ball Stopper
BBS214RMB		6.35	14	60	Ball Stopper
BBS208SMB	With slide magnet SMB	6.35	8	60	Ball Stopper
BBS210SMB		6.35	10	60	Ball Stopper
BBS212SMB		6.35	12	60	Ball Stopper
BBS214SMB		6.35	14	60	Ball Stopper
BBS0810	No magnet	6.35	H1=8 H2=10	70	Type W
BBS1012	type W	6.35	H1=10 H2=12	80	Type W
BBS0810PM	With slide	6.35	H1=8 H2=10	70	Type W
BBS1012PM	magnet WM	6.35	H1=10 H2=12	80	Type W

※We can also manufacture products with magnet.  
※マグネット入りも製作致します。

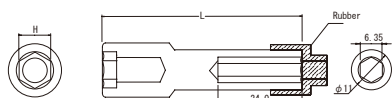

Type R

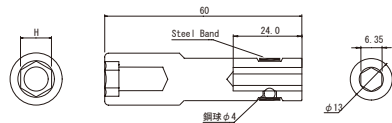

Type B

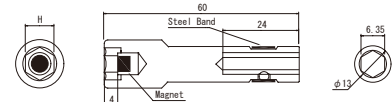

Type MB

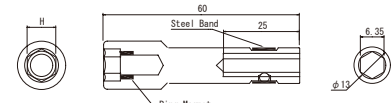

Type RMB

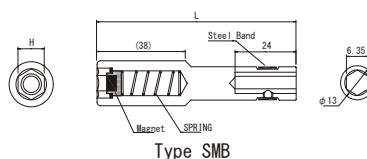

Type SMB

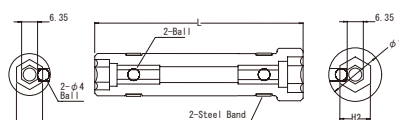

Type W

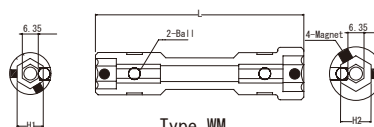

Type WM

※Attach Type R to a bit using a rubber ring separately sold.  
※Type Rは別売ゴムでビットに取付けてください。

# Adapters · Extension bars



## アダプター・エクステンションバー

### MODEL One touch bit through socket



EDP #	bit diameter	H	L	Type
BBS208AT	6.35	※8	36	
BBS210AT	6.35	10	36	
BBS212AT	6.35	12	36	
BBS213AT	6.35	13	38	
BBS214AT	6.35	14	38	

※H8 is a side magnet type.  
※H8はサイドマグネットになります。

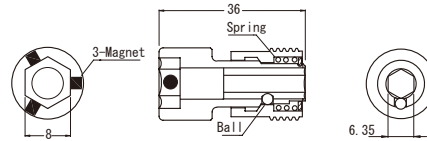
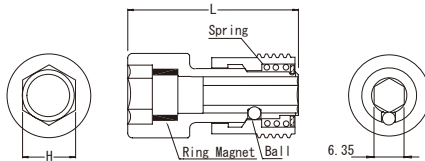

### MODEL Tap holder



EDP #	φ A	B	C	Top size
BTH-5	5.5	4.5	10	M5
BTH-6	6	4.5	10	M6
BTH-8	6.2	5	12	M8
BTH-10	7	5.5	14	M10
BTH-7/16	8	6	16	7/16 UNF
BTH-12	8.5	6.5	17	M12

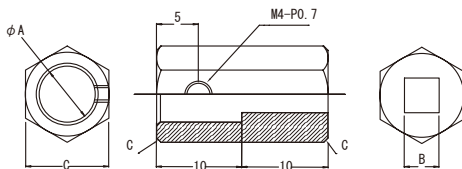

インパクトソケット

※ We can also manufacture tailor-made products based on your drawings and samples.

※その他、図面、サンプル等で特殊品の製作も承ります。